

700V Super-Junction Power MOSFET

FEATURES

- Very low FOM $R_{DS(on)} \times Q_g$
- 100% avalanche tested
- RoHS compliant
- Ultra-fast body diode
- Very high commutation ruggedness

APPLICATIONS

- Switch Mode Power Supply (SMPS)
- Uninterruptible Power Supply (UPS)
- Power Factor Correction (PFC)
- Resonant switching stages

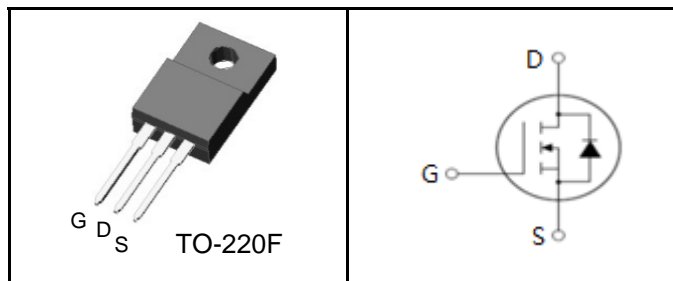

Device Marking and Package Information

Ordering Code	Package	Marking
MPSA70M300CFD	TO-220F	MP70M300CFD

Absolute Maximum Ratings $T_C = 25^\circ\text{C}$, unless otherwise noted

Parameter	Symbol	Value	Unit
Drain-Source Voltage ($V_{GS} = 0\text{V}$)	V_{DSS}	700	V
Continuous Drain Current	I_D	15	A
Pulsed Drain Current (note1)	I_{DM}	45	A
Gate-Source Voltage	V_{GSS}	± 30	V
Single Pulse Avalanche Energy (note2)	E_{AS}	300	mJ
Avalanche Current (note1)	I_{AR}	2.4	A
Repetitive Avalanche Energy (note1)	E_{AR}	0.44	mJ
MOSFET dv/dt ruggedness, $V_{DS}=0\dots 400\text{V}$	dv/dt	50	V/ns
Reverse diode dv/dt, $V_{DS}=0\dots 400\text{V}$, $I_{SD} \leq I_D$	dv/dt	15	V/ns
Power Dissipation ($T_C = 25^\circ\text{C}$)	P_D	32	W
Operating Junction and Storage Temperature Range	T_J, T_{stg}	-55~+150	$^\circ\text{C}$

Thermal Resistance

Parameter	Symbol	Value	Unit
Thermal Resistance, Junction-to-Case	R_{thJC}	3.9	K/W
Thermal Resistance, Junction-to-Ambient	R_{thJA}	80	



Specifications $T_J = 25^\circ\text{C}$, unless otherwise noted						
Parameter	Symbol	Test Conditions	Value			Unit
			Min.	Typ.	Max.	
Static						
Drain-Source Breakdown Voltage	$V_{(BR)DSS}$	$V_{GS} = 0V, I_D = 250\mu A$	700	--	--	V
Zero Gate Voltage Drain Current	I_{DSS}	$V_{DS} = 700V, V_{GS} = 0V, T_J = 25^\circ\text{C}$	--	--	2	μA
		$V_{DS} = 700V, V_{GS} = 0V, T_J = 150^\circ\text{C}$	--	--	500	
Gate-Source Leakage	I_{GSS}	$V_{GS} = \pm 30V$	--	--	± 100	nA
Gate-Source Threshold Voltage	$V_{GS(th)}$	$V_{DS} = V_{GS}, I_D = 250\mu A$	3	--	5	V
Drain-Source On-Resistance (Note3)	$R_{DS(on)}$	$V_{GS} = 10V, I_D = 7.5A$	--	0.276	0.300	Ω
Gate Resistance	R_G	$f = 1.0\text{MHz}$, open drain	--	12	--	Ω
Dynamic						
Input Capacitance	C_{iss}	$V_{GS} = 0V,$ $V_{DS} = 100V,$ $f = 1.0\text{MHz}$	--	1646	--	μF
Output Capacitance	C_{oss}		--	60	--	
Reverse Transfer Capacitance	C_{rss}		--	10	--	
Total Gate Charge	Q_g	$V_{DD} = 400V, I_D = 15A,$ $V_{GS} = 10V$	--	27	--	nC
Gate-Source Charge	Q_{gs}		--	6	--	
Gate-Drain Charge	Q_{gd}		--	10	--	
Turn-on Delay Time	$t_{d(on)}$	$V_{DD} = 400V, I_D = 15A,$ $V_{GS} = 10V, R_G = 25\Omega$	--	23	--	ns
Turn-on Rise Time	t_r		--	65	--	
Turn-off Delay Time	$t_{d(off)}$		--	105	--	
Turn-off Fall Time	t_f		--	50	--	
Drain-Source Body Diode Characteristics						
Continuous Body Diode Current	I_S	$T_C = 25^\circ\text{C}$	--	--	15	A
Pulsed Diode Forward Current	I_{SM}		--	--	45	
Body Diode Voltage	V_{SD}	$T_J = 25^\circ\text{C}, I_{SD} = 15A, V_{GS} = 0V$	--	0.9	1.2	V
Reverse Recovery Time	t_{rr}	$V_R = 400V, I_F = 15A,$ $di_F/dt = 100A/\mu s$	--	115	--	ns
Reverse Recovery Charge	Q_{rr}		--	0.42	--	μC
Peak Reverse Recovery Current	I_{rrm}		--	7	--	A

Notes

1. Repetitive Rating: Pulse width limited by maximum junction temperature
2. $I_{AS} = 2.5A, V_{DD} = 50V, R_G = 25\Omega$, Starting $T_J = 25^\circ\text{C}$
3. Pulse Test: Pulse width $\leq 300\mu s$, Duty Cycle $\leq 1\%$



Typical Characteristics $T_J = 25^\circ\text{C}$, unless otherwise noted

Figure 1. Output Characteristics

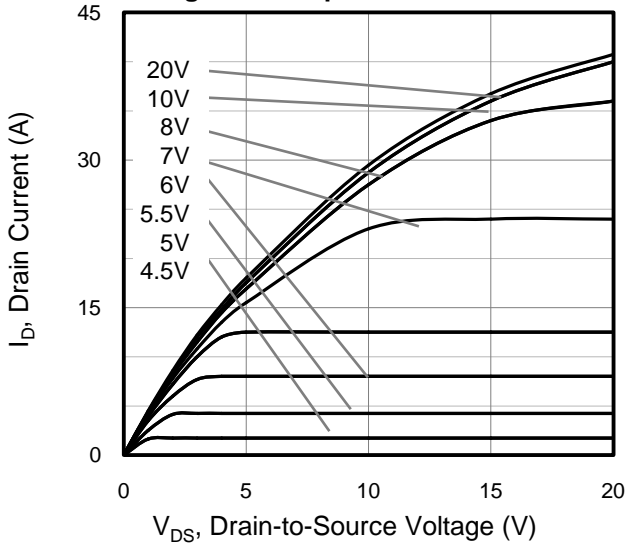

Figure 2. Transfer Characteristics

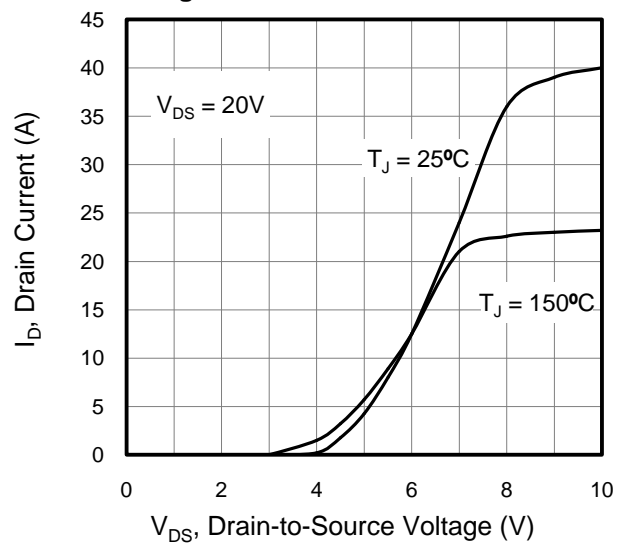

Figure 3. On-Resistance vs Drain Current

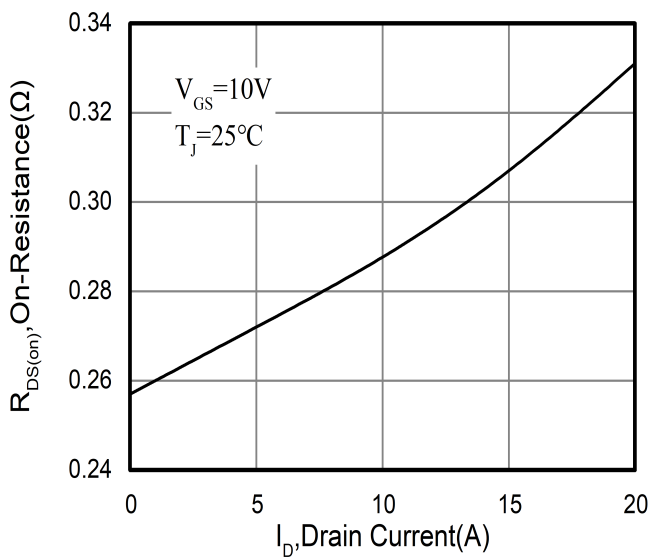

Figure 4. Capacitance

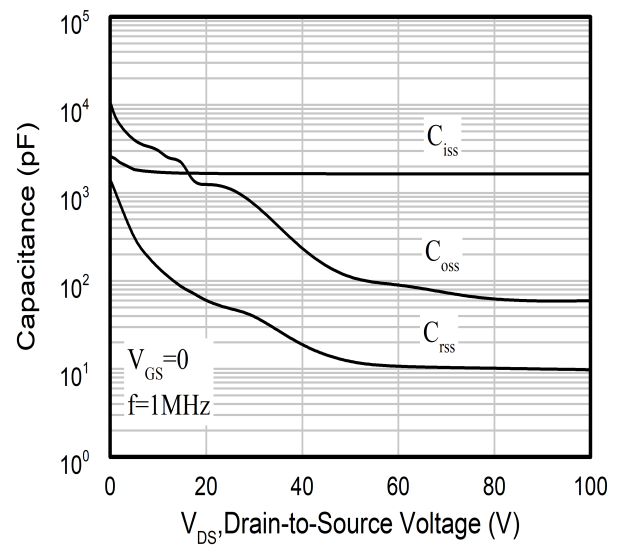

Figure 5. Gate Charge

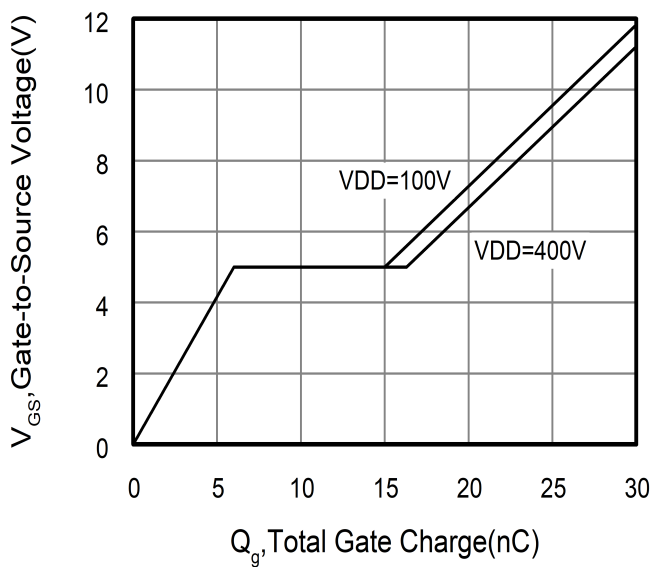
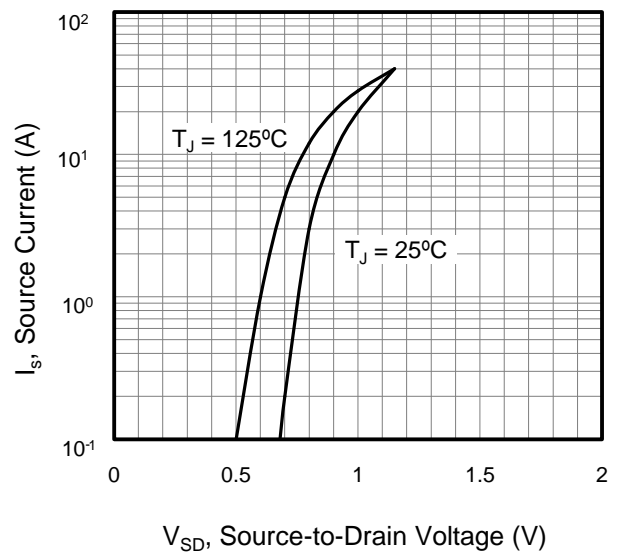

Figure 6. Body Diode Forward Voltage



Typical Characteristics $T_J = 25^\circ\text{C}$, unless otherwise noted

Figure 7. On-Resistance vs. Junction Temperature

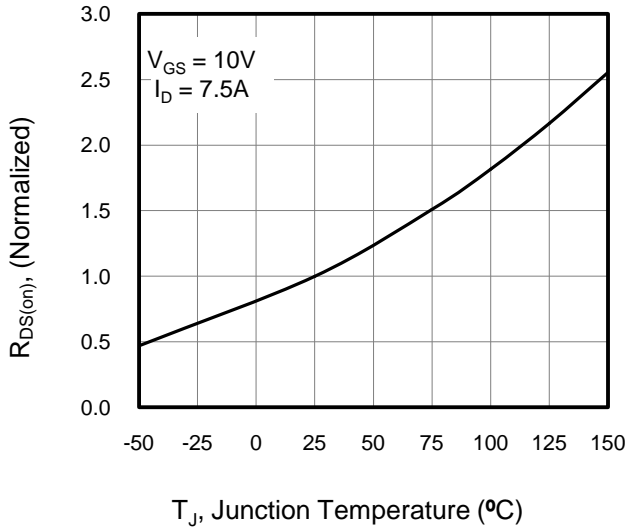

Figure 8. Breakdown voltage vs. Junction Temperature

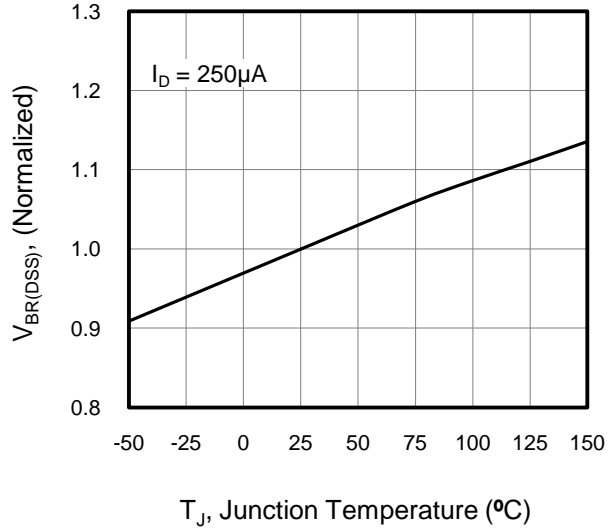

Figure 10. Transient Thermal Impedance

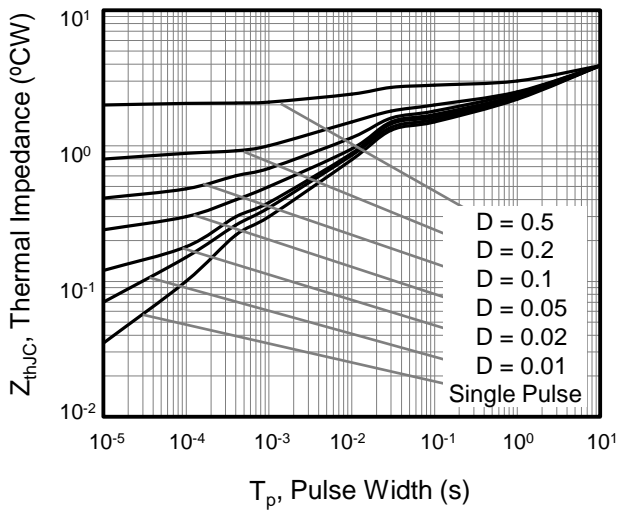

Figure A: Gate Charge Test Circuit and Waveform

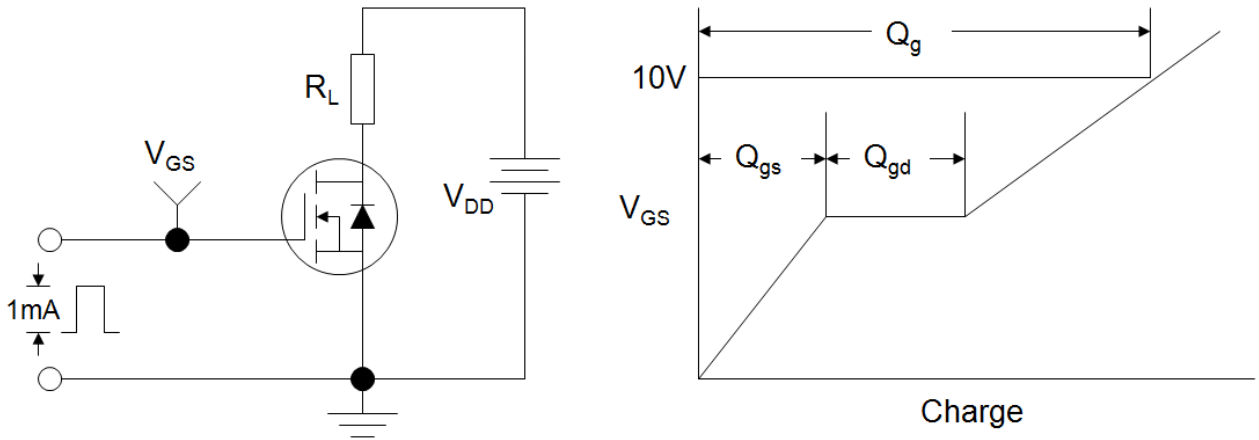

Figure B: Resistive Switching Test Circuit and Waveform

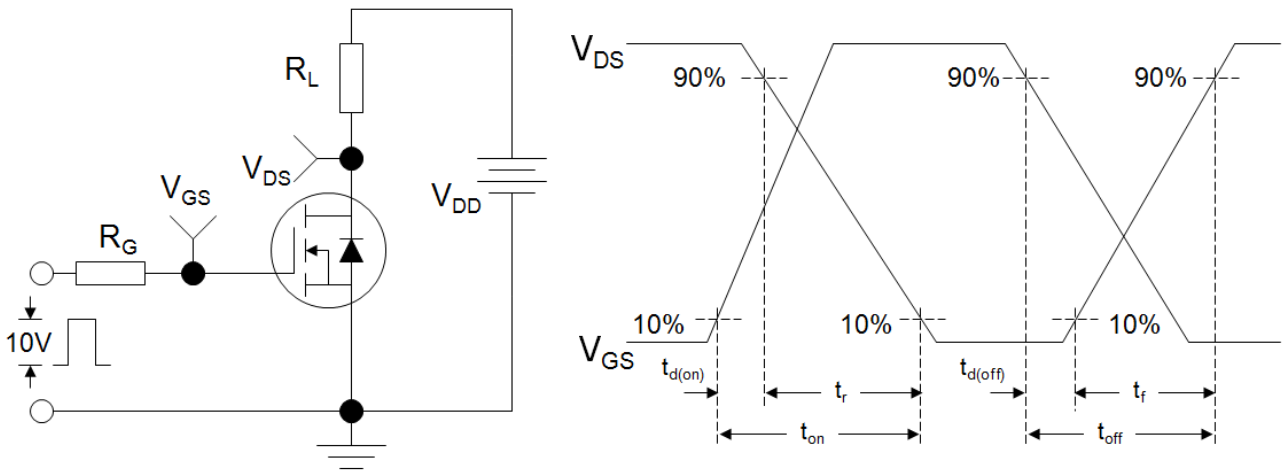
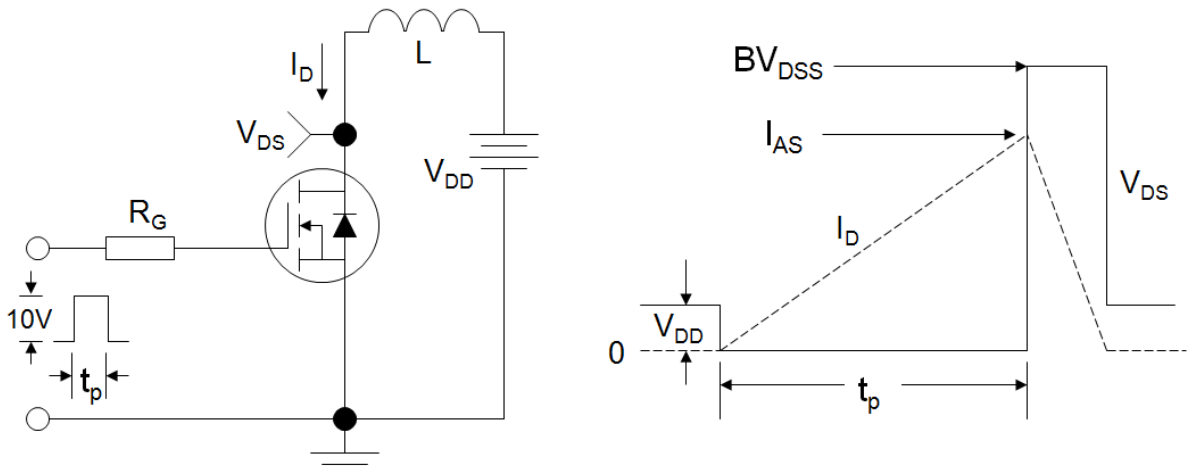
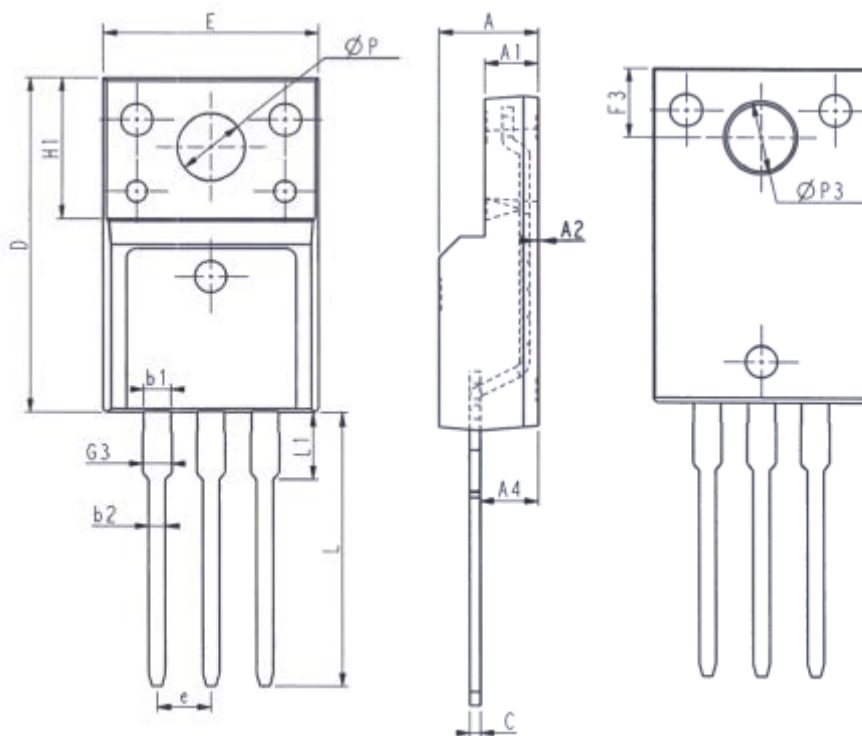

Figure C: Unclamped Inductive Switching Test Circuit and Waveform



TO-220F



Unit: mm			Unit: mm		
Symbol	Min.	Max.	Symbol	Min.	Max.
E	9.96	10.36	L	12.68	13.28
A	4.50	4.90	L1	2.93	3.13
A1	2.34	2.74	P	3.03	3.38
A2	0.30	0.60	P3	3.15	3.65
A4	2.56	2.96	F3	3.15	3.45
c	0.40	0.65	G3	1.25	1.55
D	15.57	16.17	b1	1.18	1.43
H1	6.70REF		b2	0.70	0.95
e	2.54BSC				